

GRIM REAPER Building Instructions by CRASHTESTHOBBY.COM

The Reaper is one of the toughest planes on the planet. The Grim Reaper is our club's favorite combat plane. It is also used for FPV. It has an amazing glide. It has a good speed range and is more stable than the smaller planes. It has a good power to weight with the suggested motor without spending a lot of money. It is cut from solid EPP foam that doesn't crush. It has EPP elevons that don't split. It uses a shock cord that spreads out the forces of impact. It has bidirectional reinforced Extreme Tape hinges and laminate to make it strong while protecting the battery and radio. The plane is designed to use low cost off the shelf motors, ESCs, servos and batteries. You need one of these!!!! Your club needs a bunch of these. It's time to fly without worrying about breaking your plane.



We recommend that you build and laminate the plane before you install the radio. This makes the plane easier to build and easier to service and repair. It saves time when you need to trade out electronics giving the plane a longer life with less work. We also recommend that you install all of the radio and linkages on the top of the plane to prevent linkage and radio damage when landing. The Grim Reaper airfoil design needs fins for stability.

Specifications

- a) Center of gravity is back 10.5" (26.5 cm) from nose of plane. This plane will not fly well nose or tail heavy.
- b) The Reaper tends to build tail so you will need to keep the batteries far forward.
- c) Front spars are back 1.5" from the leading edge of wing on both right/left and top/bottom of the wing.
- d) Center spars are back 10" (25 cm) from nose of plane on both the top and bottom of the wing.
- e) Spars are tied together with wire joiners and reinforced Scotch Extreme Tape over the top to prevent separation.
- f) Elevon throws 3/8" (1 cm) up/down. Use hole close to center of servo and hole at top of elevons horn for best leverage.
- g) Target all up weight 36-44 oz (1080-1320 gm). Lighter always flies better.
- h) 3530-1700 KV motor recommended with 7x6 propeller. (Some flyers are using the 3530-1400 KV with a 9x6 prop)
- i) Use a 40-60 amp ESC (Electronic Speed Control) Install it so there is airflow around it
- j) 2200-4000 mah 3S lipo batteries mounted with the side facing forward to absorb impact.
- k) Standard sized servos recommended for any motor capable of over 20 amps.
- l) Speed range 15-85 mph with suggested motor and standard build.

Equipment needed

- a) Low-temperature hot glue gun and low-temp rated glue
- b) (OPTIONAL) Gorilla Glue (preferably white), or "Goop" brand glue
- c) #6 x 3/4" screws to attach motor mount to Formica (2-56 bolts and nuts may also be used)
- d) Scotch Extreme Tape (2" bidirectional) available at office supply shipping departments and on AMAZON
- e) Metal straight edge that won't melt when used as a guide for the soldering iron or cut with a razor blade
- f) Soldering iron with 5/16" wheel collar to set cutting depth
- g) Pliers for cutting pushrod to length
- h) New razor blade to cut slit for shock cord
- i) Small Philips head screwdriver to push shock cord into slit
- j) Electric drill and bits for attaching motor mount to Formica plate.
- k) Iron for applying laminate (hobby iron is preferable, but clothing iron may be used)
- l) Velcro strips

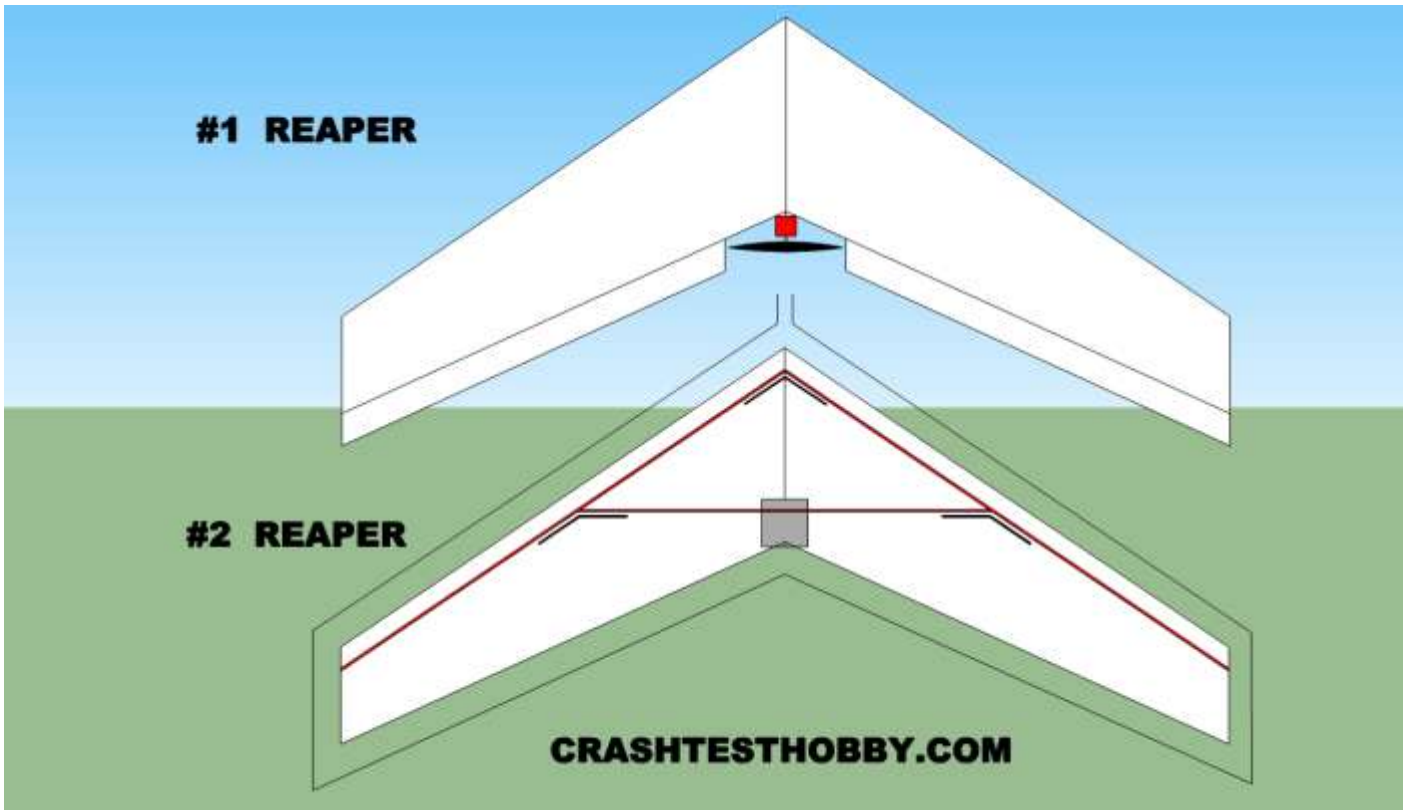

REAPER BUILDING INSTRUCTIONS

1. Image #1 shows plane parts and shape.

- Clean EPP cut fibers off cores by rubbing the cores together or using a disposable razor to shave the cores.
- Glue core halves together with HOT GLUE or Goop or Gorilla glue. Hot glue is faster and easier.
- Cut elevons to length and angles on the end making adjustments for prop size.
- Leave 1/2" clearance on each side of prop.

2. Image #2 shows spars, reinforcement wire, shock cord, Formica plate.

- The spars and Formica plates are installed the same on both the top and bottom of the wing.
- The front spars are back 1.5" from the leading edge of the wing and meet in the middle.
- The center spars are installed across the center of the wing back 10" from the nose of the plane.



- d) Cut the spar slots with a soldering iron and a metal straight edge.
- e) Cut the tip of a soldering iron off to 1/4" or slide a 5/16" wheel collar on the shaft of the soldering iron to set the depth.
- f) 6" wires are bent to fit in the spar slots to keep the spars from separating in an accident.
- g) Enlarge the slot slightly where the wire will be installed to give spars room to lay flat over the wires.
- h) Glue the angle wires in the slots to keep the spars from separating.
- i) Hot glue the spars in the slots making sure they are well secured to the angle wires.

The shock cord keeps the plane from tearing between the elevons in a forward impact.

- j) Cut a 1/4" deep slit around the perimeter of the wing with a brand new razor blade to get the best cut.
- k) Push the shock cord in the slit with a small Phillips screwdriver and tie securely at the nose of the plane.
- l) Glue shock cord in place with thin CA glue. (Some builders wet the shock cord and use Gorilla glue in the slit.)

The Formica plates attach the motor mount to the spar system across the center of the plane.

- m) The Formica plates should hang slightly over the trailing edge in the center so the motor mount will rest on the Formica not the foam wing core.
- n) Formica plates are glued on both the top and bottom in the center of wing directly over each other. Motor mount will be on the bottom of the wing attached with #6 screws or longer 2-56 bolts with nuts on top side of wing.

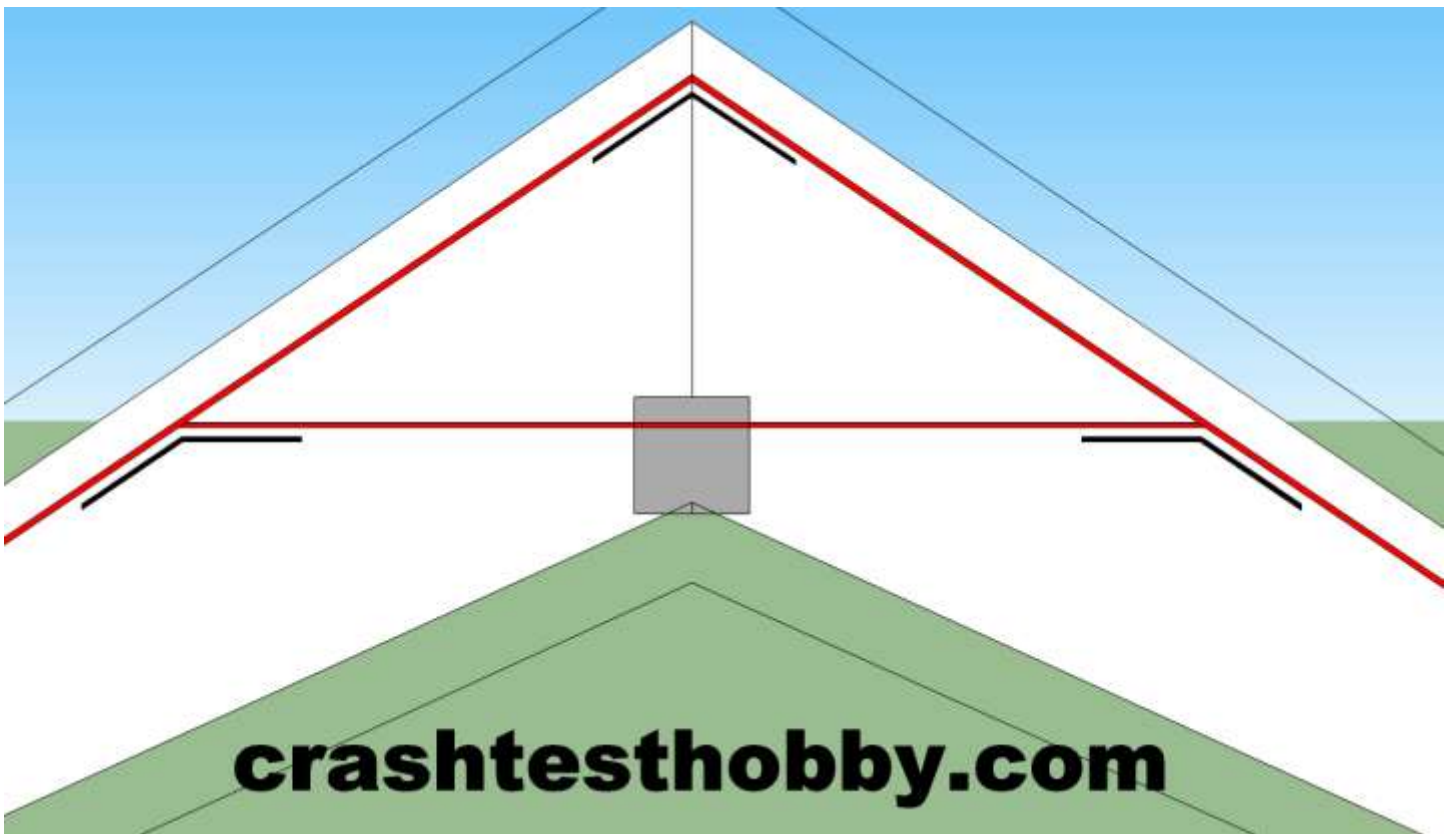

The above picture shows the red spars, black 6" wires that are glued into the slots before the spars are installed and the Formica motor mount plate hanging slightly over the trailing edge of the wing to better support the metal motor mount. It also shows a line representing the shock cord that is inserted around the perimeter of the wing. The plane in the pictures was built with leading edge tip angles that we do not recommend. The Reaper airfoil flies much better with fins.

Below you can see simple installation of the shock cord.

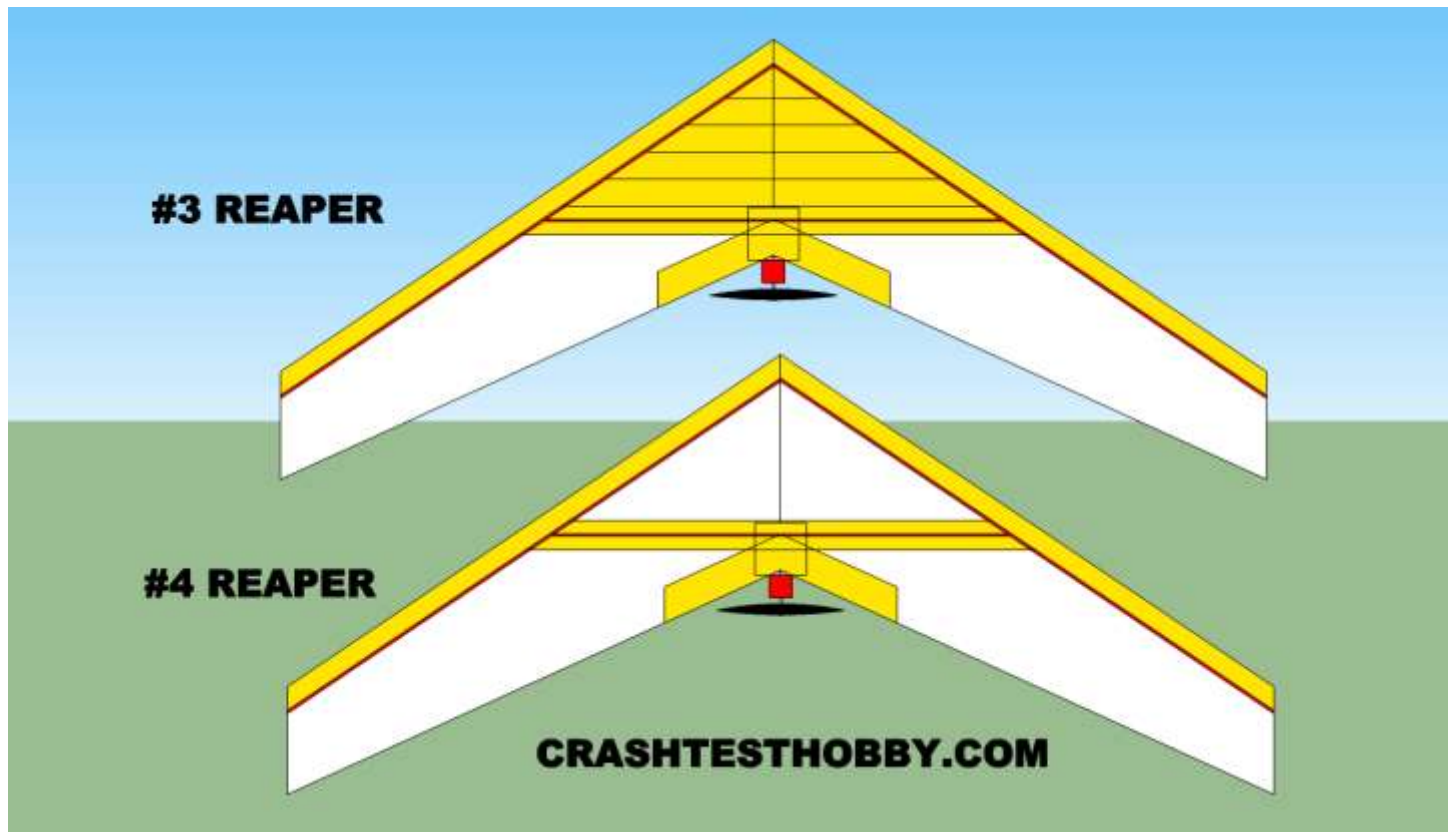

3. Image #3 shows the Reinforced Tape pattern for the bottom of the wing. We recommend "Scotch Extreme Tape"

- a) Extreme Tape will stick without a spray adhesive.
- b) It should be tight enough to give strength but not so tight it warps the wing.
- c) A strip of Extreme Tape should be over every spar to increase plane strength.
- d) The tape is **YELLOW** in the picture. Foam is **WHITE** and spars are colored **RED** for identification.
- e) The battery will be held in by this layer of tape on the bottom of the wing.
- f) Put 2" strips of Extreme tape from the bottom spar forward.
- g) Wrap 2" E-Tape around leading edge of wing to tie in all the cross pieces on the top and bottom of the wing.
- h) For maximum strength you can wrap laminate from front spar on top to front spar on bottom.

4. Image #4 shows the top of the wing and the reinforced tape pattern.

- a) Extreme Tape across center of wing directly over the spar.
- b) The tape shown on the trailing edge of the wing secures the Formica plates and adds strength to the shock cord between the elevons helping to prevent the plane from tearing between the elevons in a forward impact.
- c) The rear tape should overlap 4" inches on the hinge line of the elevons for maximum effect.
- d) Wrap 2" reinforced tape from tip to tip along the leading edge of the wing.

ALL REINFORCED TAPE MUST BE COVERED WITH LAMINATE TO PROTECT FROM UV RAYS THAT DESTROY ITS ADHESIVE.

5. See images #5 and #6. Laminating the wing.

- a) Test the temperature your iron with a scrap of laminate on the cardboard box. The laminate should stick and slightly shrink but the iron should not be so hot it changes the shape of the foam. This is important on the elevons that are thinner so more sensitive to the heat
- b) Put a single layer of laminate on top and bottom of wing over foam and tape
- c) Cut laminate pieces that will cover 1/2 of one side of the wing with a 2" overlap.
- d) Lay the laminate flat on the wing with the rough side against the foam and take a single stroke down the middle of the wing trying not to leave wrinkles.
- e) Work from this line and iron towards the edges avoiding wrinkles or too much heat.
- f) Wrap the edges and ends to get a great look. Pictures shown of lamination on smaller plane to better show the process.

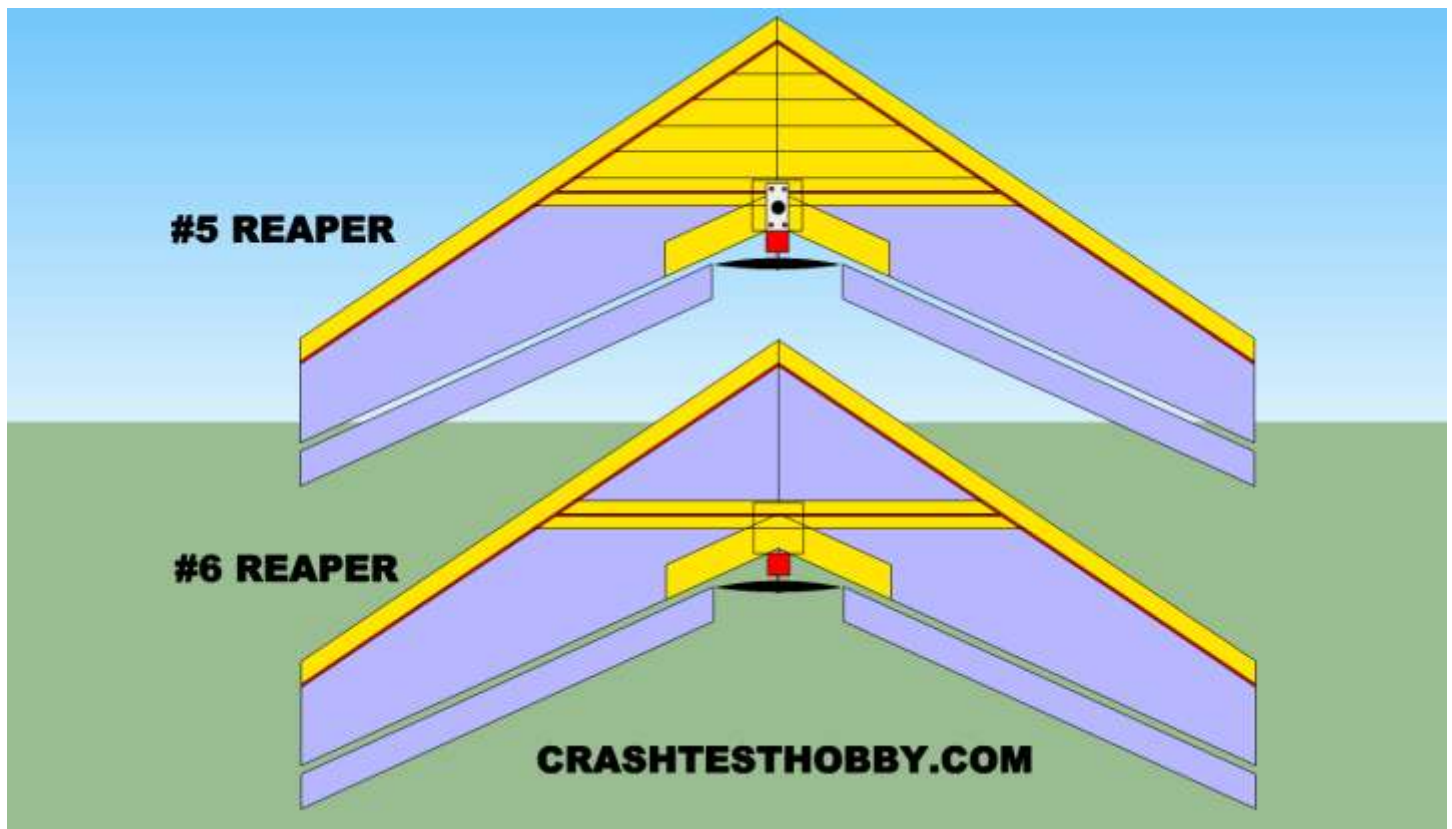

5. Images #5 and #6 show bottom and top details of the laminated wing and the mounting of the motor.

The BLUE color represents the clear laminate we include in the kit which is ironed onto the core over the foam and tape. Although the tape is still shown yellow you will need to put laminate over the tape to protect it from UV rays that will break down the adhesive and rot the tape in a matter of a few hours in the sun without protection. The Scotch Extreme Tape is not yellow but is almost as white as the foam and will stay white if protected with the laminate. The laminate we include in the kit does NOT need a spray adhesive to get it to stick.

Laminating the elevons

- g) **Iron 2 layers of laminate on the EPP elevons. Two layers of laminate on the elevons make them as stiff as balsa.**
- h) Be careful not to warp the elevons during lamination.

- a) Place one of the elevons under one edge of the laminate, so that the rough side of the laminate is facing the EPP foam.
- b) Wrap the laminate end up over the elevon and make sure the elevon is straight before ironing.
- c) Use your iron to stick the laminate to the foam. Begin at the center and work your way outward to avoid wrinkles.
- d) Fold the laminate over and continue ironing until the elevon is completely covered with two layers of laminate.
- e) Check the elevon frequently to make sure it is straight.
- f) Cut the extra laminate on the ends of the elevon to fold over neatly. Iron the laminate around the ends of the elevon. Repeat process with other elevon.
- g) The heat and laminate shrinkage can warp the foam.
- h) If needed, re-heat and straighten the elevon, then hold it flat while it cools.
- i) The elevons will still be bendable until they are hinged to the back of the wing.

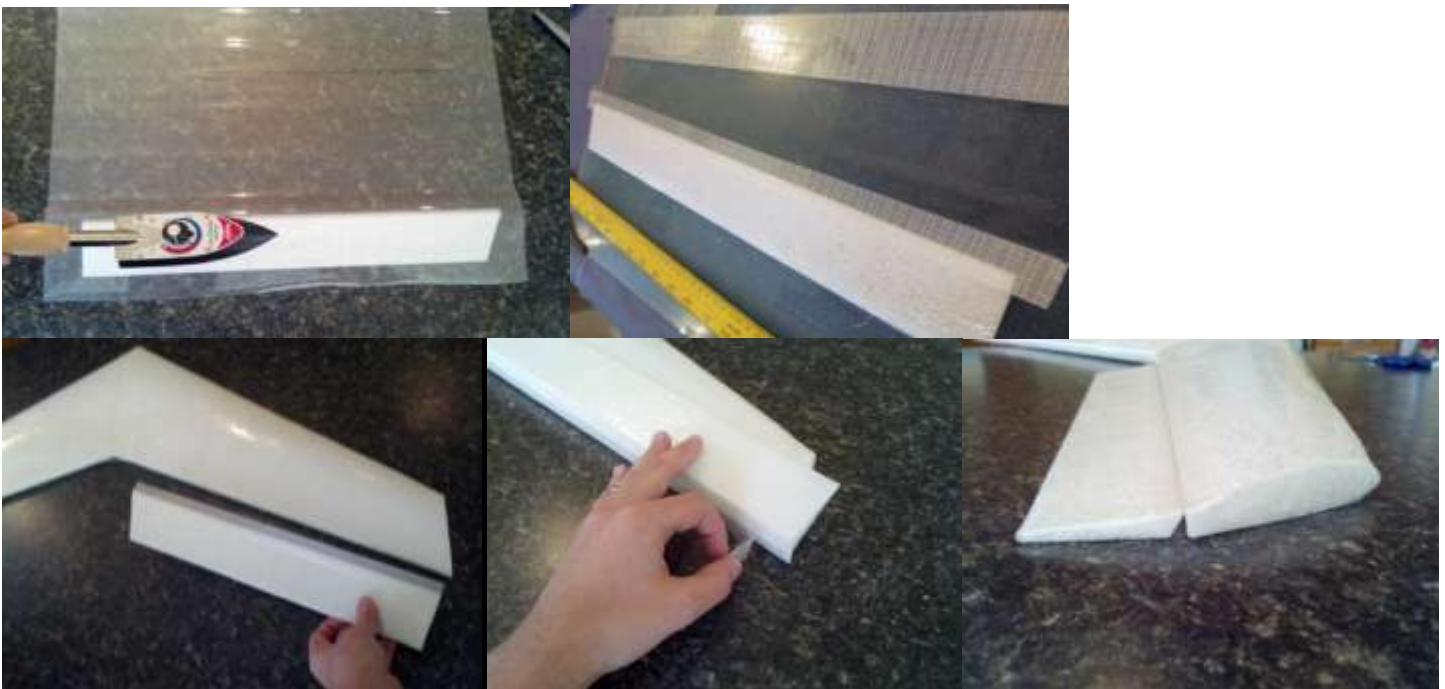
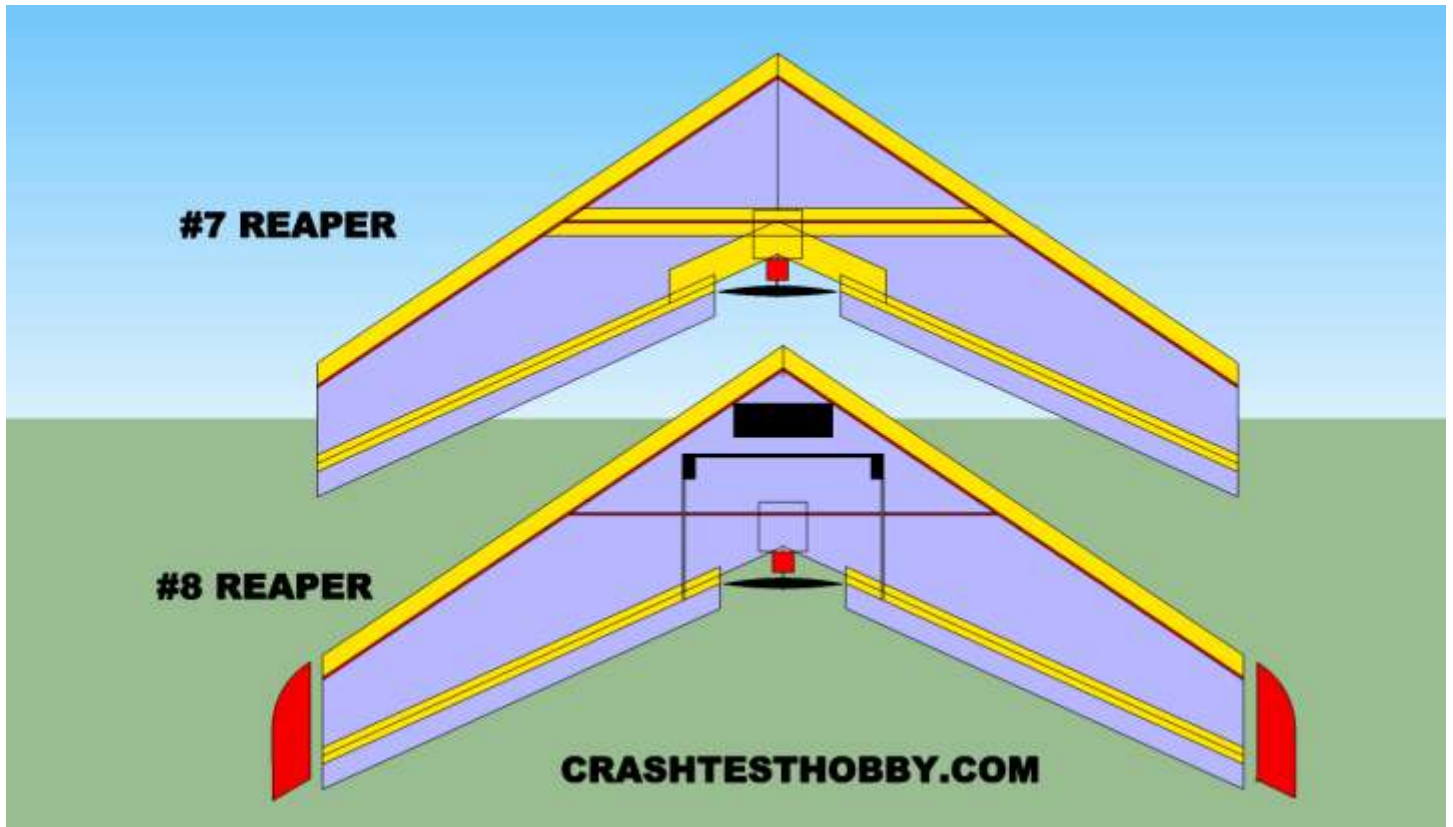



7. Image #7 shows the tape hinges and suggested radio installation.

- a) The Extreme Tape has bidirectional reinforced fibers making a strong hinge line.
- b) The E-Tape hinge line will also need a layer of laminate to protect it from UV light.
- c) Position your elevons so the hinge line (sharp angle on the elevon) is on the top of the wing
- d) Cut strips of the Scotch Extreme Tape 1" wide by sticking the tape to a piece of glass or Formica and using a new razor blade and metal straight edge.
- e) Leave a 1/16" gap between the elevon and the wing core.
- f) Put the tape the entire length of the elevon.
- g) Fold the elevon up over the wing and put a 1" strip of E-Tape on the bottom of the hinge line.
- h) Iron 2" wide laminate strips over tape on both the top and bottom of the hinge line to protect from UV light.
- i) The hinge will not lay flat until you iron it in both the flexed up and flexed down positions.
- j) Look down the elevon and make sure it lays flat and is not warped.

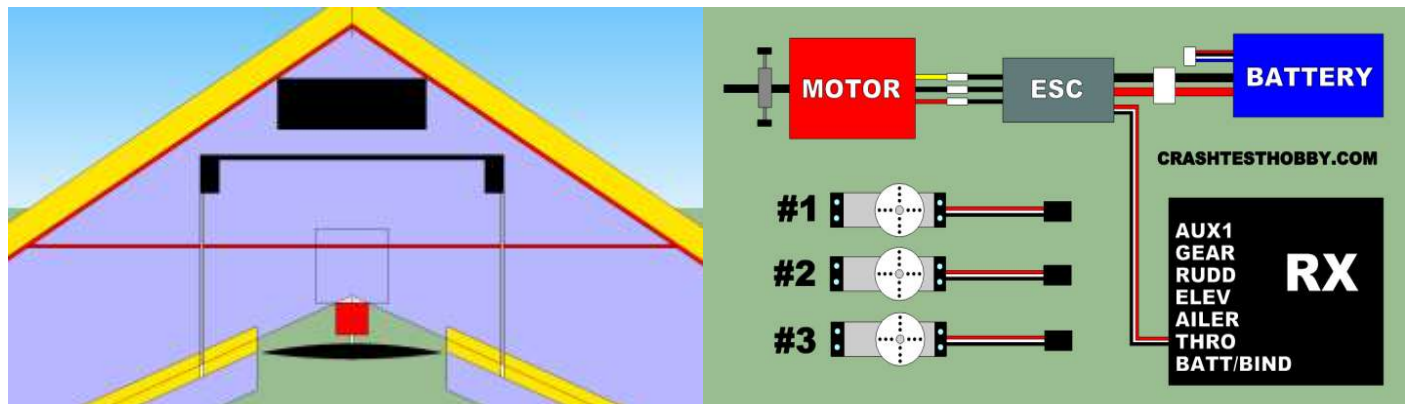

9. Installing the radio

- a) The suggested locations in the picture should be close to the best location to get the CG at the suggested 10.5" back.
- b) Install your motor and mount and fins on the tips of the wing before you check the CG.

MOTOR – We recommend the 3530-1700 KV motor with 7X6 propeller or the 3530-1400 KV motor with a 9x6 prop. The 1700 KV motor is a little faster, the 1400KV motor has a better climb and is quieter.

- a) Use 3mm bolts to mount the 3530 motor body to the back of the bracket.
- b) With the wing upside-down, place the motor mount on the Formica plate, and mark where the holes will be drilled
- c) Drill pilot holes through the Formica plates and plane.
- d) Screw the bracket to the Formica plate using #6 x 1/2 " metal screws or on both top and bottom plates by using longer 2-56 bolts with lock nuts, being careful not to over-tighten and crack the Formica. You can leave the motor mounted to the bracket to properly measure the Center of Gravity later, but remove the prop for safety purposes.



- c) Hold the fins in place against the ends of each wing top, and make a 1" (2.5cm) mark in the center of the fin, where it meets the top of the wing, then use your razor blade to cut out that 1" (2.5cm) section in the fin.
- d) Shape the nose and top of the fin as desired.



- e) Use Goop (or Shoe Goo) to glue the fins to the ends of the wings, with the slit just above the top of the wing.
- f) Place a 2" (5cm) wide strip of Extreme Tape along the entire bottom of the fin, wrapping around to the bottom of the wing. Allow the glue to dry.
- g) Cut a 1" (2.5cm) wide strip of Extreme Tape and feed it through the slit in the fin, so that the tape attaches to both the top and bottom of the wing, around the bottom portion of the fin.

Installing the electronics.

- a) Pre- test the motor, batteries, ESCS, receivers and servos that you plan to install to know everything is working.
- b) Set the parts on the top of the plane where shown and see if the CG needs to be adjusted.
- c) Look at the length of the wires between the battery and ESC and the ESC and the receiver. This often will influence where you will install the radio.
- d) Spread your servos wide enough apart so that the servo arms will have a good angle to the horns on the elevons. The servos will need to be 12"-14" apart. Make sure the servo electrical wires will reach. (You may need to use a servo extension or two.)
- e) Move the battery forward or back to get the CG 10.5" back from the nose of the plane.
- f) The wing is stronger if you leave no empty space in the wing so cut out compartments that fit tightly.
- g) Install the servos with the servo arms on away from the center of the plane for maximum width.
- h) The radio slot can be cut deep and wide enough to allow you to put the ESC and receiver on their side in the slot or you can cut separate compartments for the battery, ESC and receiver and connect them with razor blade slits for the wires to be pressed into the foam. Put clear shipping tape or laminate over any slit or slot with wires.
- i) Once all components are installed hot glue **the servos** securely in place with only glue around the sides and not under the servo so you can remove it later if needed without damaging the plane.
- j) You can use Velcro straps to secure the battery, ESC and receiver as needed. In some cases I have used clear tape to secure the radio but make sure the ESC has adequate ventilation so it doesn't overheat.
- k) Elevon throws are 3/8" Trim both elevons up 1/4" (reflex).
- l) Secure all parts so they can't fall out or get knocked out in an accident.

PUSH RODS AND SERVO HORNS

- a) Put your push rods on the outside of the servo arms to get the maximum width. This allows you to place your push rod slightly further out the elevon, reducing the force required to move the entire elevon, and reducing any chance of twist in the elevon. You will want to use the hole closest to the servo.
- e) Use the push rod to measure directly back from the hole in the servo arm, and place a mark on the front edge of the elevon. Depending on your servo, you may need to use a small drill bit to widen the hole in the servo arm, so that the rod fits through.



- f) Use a sharp blade and cut a slit completely through the elevon where you want the horn. The mark you made in the previous step should be the *inside edge* of that slot, not the center to allow enough room for the EZ Connector on the servo horn.
- g) Remove the extra tab that comes attached on the back of the servo horns.
- h) Push the servo horns up through the bottom of the elevon so that the base is flat against the bottom of the elevon.
- i) Use hot glue along the base of the servo horn, and down through the melted slot, around the horn, to keep horn in place. As the hot glue dries, make sure the horn is facing straight forward.
- j) Your horns should point towards the servos, and the front of the horn should be directly over the elevons hinge.



- k) Attach the EZ Connectors to the control horns with a pair of pliers to the top hole in the control horn.
- l) Remove the servo arms, slide the push rod Z-bend through the hole in the servo arm. Place the end of the push rod through the EZ Connector, then set the servo arm back on the servo.
- m) Mark a spot on the wing about halfway between the servo and the elevon, directly underneath the push rod.
- n) Remove the push rod, and use your soldering iron to melt a hole at the mark you just made. This hole should be wide enough and deep enough that the push rod guide (the metal staple included in the kit) can sit in it, and extend just over the push rod.
- o) Fill the hole with hot glue, and set the push rod guide (staple) in place. Hold it there while the glue dries. The staple keeps the push rod from flexing to the sides/up and down to keep the rod more stable.
- p) Permanently attaching the push rods from servo arm to servo horn is best done later. This allows you to properly set the sub trim once all electronics are installed. It also keeps the rods out of the way as you finish the build.



BATTERY BAY – VELCRO RETENTION STRAPS

1. To hold the battery in place during flight, you can install Velcro strap. A simple way to do this is to cut a slit through the bottom front of the battery hole and one through the bottom in the middle of the slot that contains the radio and then feed the Velcro through and fasten it on the top of the wing. The Velcro over the wires will help hold the receiver and ESC in place along with securing the battery. See photo above.

PUSH RODS & ELECTRONICS TESTING

- a) You will need elevon, delta or programmable mixing to mix the aileron and elevator channels to fly a plane with elevons.
- b) Consult your radio manual for help if needed. On the Spektrum DX6i you may want to do manual mixing as described on our web site.
- c) Remove the servo arms from the servos. Connect all electronics, including a battery, but for safety purposes, make sure you do not have prop attached to your motor at this point. Turn on your transmitter(tx) and allow the servo gears to “center” themselves.
- d) Slide the push rod through the closest hole to the servo in the servo arm (still unattached to the servo), then slide the end of the push rod through the guide, and into the EZ Connector on the elevon. Then re-attach the servo arm to the servo so that the arm is perpendicular to the push rod.



- e) With the EZ Connectors still loose, center the Subtrim function on your transmitter then put the servo arms perpendicular to the push rod.
- f) Let the EZ Connector slide over the push rod as you lift your elevon so that the angle of the top of the elevon is parallel to the bottom of the wing. This is an approximate angle and may need to be adjusted during test flights depending on CG and weight. This is called **REFLEX** and is used on all flying wings and deltas.
- g) Once in place, tighten the set screw on the EZ connector, and use snips to trim off excess push rod.
- h) Repeat on other elevon and set it at the same angle.
- i) Set the wing on a flat surface, and hold a ruler vertically next to the trailing edge of each elevon. Use your tx to set the throw (range of movement) on the elevons to 3/8” (1cm) up and 3/8” down. Make sure your stick movement translates to the proper up/down on your elevons:

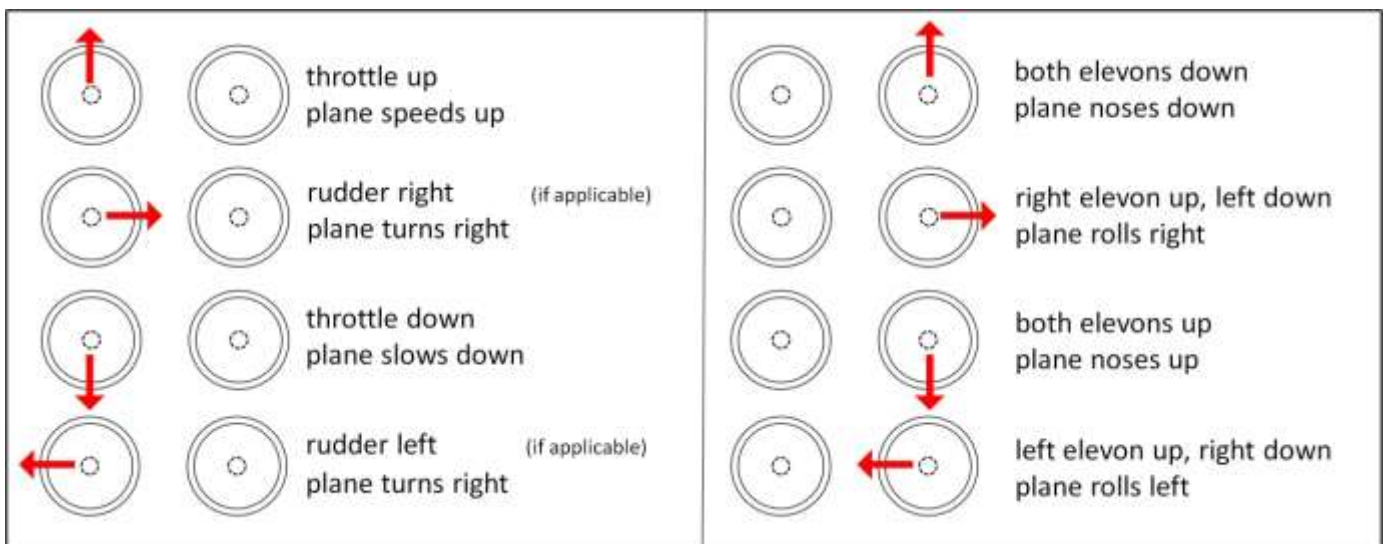

ELECTRONICS COVERING, DECALS, & FINIS

- After testing all electronics, cover your receiver, ESC, and the slots you buried wires in, with clear tape and/or laminate to keep the radio from ejecting in an accident. The ESC gets hot and needs ventilation. The receiver and wires do not.
- Add any other decals as you wish, but be careful not to add so much that it changes the Center of Gravity. *The lighter, the better!*
- Install prop with numbers facing the plane (if prop is installed backwards, it will not give you the necessary power).
- Test the throttle and make sure the motor is turning in the correct direction. If not, unplug two of the three connectors between the motor and the ESC and reverse them. Try again.
- Check your CG, the throw on the elevons, your linkages and reflex (slight up trim on the elevons) before launching.
- It's always a good idea to have someone else double check your work. Field test and range check your equipment, then launch, trim, and enjoy!

LAUNCHING

Launching from the tip is an art form and hard for many new flyers. In the videos you see us launch our flying wings holding the plane by a wingtip while swinging it forward. We are actually setting the plane on the air without Frisbee spinning the plane. If you spin the plane at all the outside wing will have more lift because it is moving faster and the plane will roll the opposite direction and hit the ground. If you have any trouble, launch from the center of the plane with fingers on each side of the motor and toss the plane at the horizon. Don't throttle up till your hand is clear of the propeller.

The most common problems we see are:

- CG too far back.** Flying wings will not fly tail heavy. A good sign you are tail heavy is you can't control the plane or the plane won't stay trimmed. When you try to loop the plane will roll over. Add weight to the nose to see if the problems resolve. It is not uncommon to need an extra oz or two of lead depending on how light you build.
- Too much movement in the elevons** so the plane stalls on launch as you pull up on the elevator. Our planes have huge elevons to decrease drag so they don't need as much movement in the elevons as planes with small elevons. This is a very common problem!!!! May be combined or confused with tail heavy airplane symptoms.
- Loose servos in the foam, linkages and push rods that flex, and poor leverage with push rods not installed per plans, elevons are too soft and twisting.**

We design our planes to use the same inexpensive motors, ESCs, batteries and servos to save you money and keep you flying.

Try all of our planes. They each have their own personality. If you are a new flyer and having trouble learning, spend some time on a simulator or get some hours on one of our slow fly planes like the Storm Chaser or Albatross to help you learn to fly.

